





**Capi perfetti per te, che ti esprimi nel tuo lavoro
con cura e raffinatezza in ogni momento.**

Grembiuli e gilet con tessuti ricercati e linee studiate nei minimi dettagli, per indossare ogni capo come un abito su misura. Se ti muovi in un ambiente in cui distinguersi con classe, **G'Elegance** è la collezione giusta per te.

Elegance

COLLECTION

Perfect garments for those who express themselves through their work, with care and sophistication in every moment.

*Aprons and waistcoats of refined fabrics and designed in details, to be worn like a tailored suit. If you act in an environment where standing out is the rule, **G' Elegance** is the right collection for you.*

ho.re.ca.
& services

ho.re.ca. & services

Gilet e grembiuli coordinati
Matching waistcoats and aprons

MIGUEL

Dettagli / Details

- 2 tasche
- 4 bottoni 4 fori
- Fodera stretch sulla schiena

- 2 pockets
- 4 buttons with four holes
- Stretch lining on the back

Taglie / Sizes

S ÷ 3XL Slim Fit

Art. 23P01E355

S119 Scozzese grigio / Scottish grey

Tessuto / Fabric

80% poliestere 18% viscosa 2% elasthan
80% polyester 18% viscose 2% elastane
180 g / m²

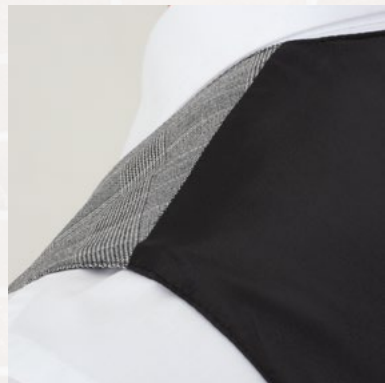
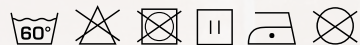

COMFORT



COMFORT

CORA

Dettagli / Details

- 2 tasche
- 4 bottoni 4 fori
- Fodera stretch sulla schiena

- 2 pockets
- 4 buttons with four holes
- Stretch lining on the back

Taglie / Sizes

XS ÷ XXL Slim Fit

Art. 23P01E356

S119 Scozzese grigio / Scottish grey

Tessuto / Fabric

80% poliestere 18% viscosa 2% elasthan
80% polyester 18% viscose 2% elastane
180 g / m²

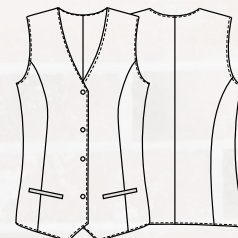

ho.re.ca. & services

Gilet e grembiuli coordinati
Matching waistcoats and aprons

ALLEGRA

Dettagli / Details

- Chiusura regolabile con laccio
- 1 grande tasca
- 2 spacchetti laterali
- Coperto dietro

- Adjustable fastening with string
- 1 big pocket
- 2 side vents
- Covered backside

Taglie / Sizes

I - II Regular Fit

	I	II
Torace / Chest	80-96 cm	97-121 cm
Bacino / Hips	84-104 cm	105-124 cm

Art. 23P01K360

S119 Scozzese grigio / Scottish grey

Tessuto / Fabric

80% poliestere 18% viscosa 2% elastan
80% polyester 18% viscose 2% elastane
180 g / m²

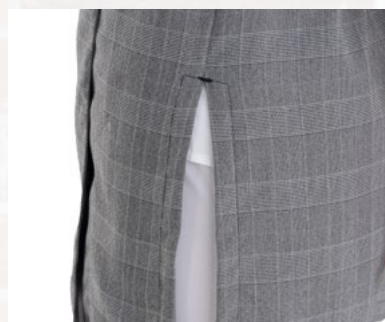
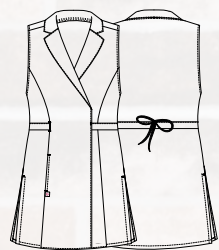

COMFORT





KENTUCKY

Dettagli / Details

- Allacciatura collo regolabile con bottoni
- 2 tasche

- Adjustable halter with buttons
- 2 pockets

Taglie / Sizes Taglia unica / One size

Art. 23P01H357

S119 Scozzese grigio / Scottish grey

Tessuto / Fabric

80% poliestere 18% viscosa 2% elasthan
80% polyester 18% viscose 2% elastane
180 g / m²

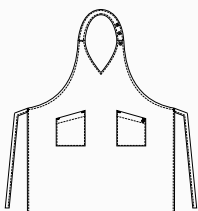

TEXAS

Dettagli / Details

- 1 tasca

- 1 pocket

Taglie / Sizes Taglia unica / One size

Misure / Dimensions

80x70 cm

Art. 23P01H358

S119 Scozzese grigio / Scottish grey

Tessuto / Fabric

80% poliestere 18% viscosa 2% elasthan
80% polyester 18% viscose 2% elastane
180 g / m²

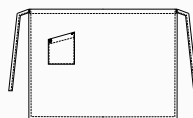

FLORIDA

Dettagli / Details

- Allacciatura collo regolabile con bottoni
- 1 tasca

- Adjustable halter with buttons
- 1 pocket

Taglie / Sizes Taglia unica / One size

Art. 23P01H359

S119 Scozzese grigio / Scottish grey

Tessuto / Fabric

80% poliestere 18% viscosa 2% elasthan
80% polyester 18% viscose 2% elastane
180 g / m²

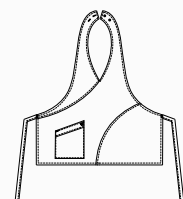

ho.re.ca. & services

Gilet e grembiuli coordinati
Matching waistcoats and aprons

MIGUEL

Dettagli / Details

- Foderato
- 2 tasche
- 4 bottoni a pressione
- Fodera stretch sulla schiena

- Lined
- 2 pockets
- 4 press studs
- Stretch lining on the back

Taglie / Sizes

S ÷ 3XL Regular Fit

Art. 22P01E305

J004 Jeans blu / Blue jeans

Tessuto / Fabric

62% cotone 35% poliestere 3% elasthan
62% cotton 35% polyester 3% elastane
180 g / m²

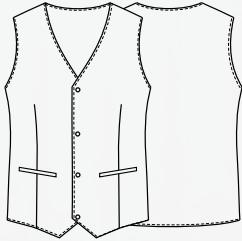

COMFORT



COMFORT



ho.re.ca. & services

Gilet e grembiuli coordinati
Matching waistcoats and aprons

CORA

Dettagli / Details

- Foderato
- 2 tasche
- 4 bottoni a pressione
- Fodera stretch sulla schiena

- Lined
- 2 pockets
- 4 press studs
- Stretch lining on the back

Taglie / Sizes

XS ÷ XXL Slim Fit

Art. 22P01E306

J004 Jeans Blu / Blue jeans

Tessuto / Fabric

62% cotone 35% poliestere 3% elasthan
62% cotton 35% polyester 3% elastane
180 g / m²

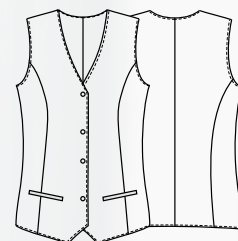



COMFORT



ALABAMA

Dettagli / Details

- Allacciatura collo regolabile con automatico
- 2 tasche
- 3 taschini portapenne

- Adjustable halter with press stud
- 2 pockets
- 3 pen pockets

Taglie / Sizes

Taglia unica / One size

Art. 22P01H307

J004 Jeans blu / Blue jeans

Tessuto / Fabric

62% cotone 35% poliestere 3% elastan
62% cotton 35% polyester 3% elastane
180 g / m²

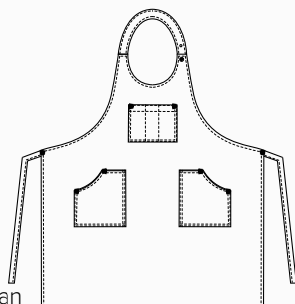

MISSOURI

Dettagli / Details

- Baschina per nascondere il laccio
- 1 tasca

- Basque to hide the string
- 1 pocket

Taglie / Sizes

Taglia unica / One size

Misure / Dimensions

90x80 cm

Art. 22P01H308

J004 Jeans blu / Blue jeans

Tessuto / Fabric

62% cotone 35% poliestere 3% elastan
62% cotton 35% polyester 3% elastane
180 g / m²

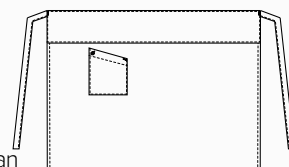



Art. 22P01H307
J004 Jeans blu / Blue jeans

ho.re.ca. & services

Gilet e grembiuli coordinati
Matching waistcoats and aprons

JULIO

Dettagli / Details

- Foderato
- 2 tasche
- 4 bottoni 4 fori
- Fodera stretch sulla schiena

- Lined
- 2 pockets
- 4 buttons with four holes
- Stretch lining on the back

Taglie / Sizes

S ÷ 4XL Slim Fit

Art. 24P01E405

000 Nero / Black

Tessuto / Fabric

95% poliestere 5% elasthan
95% polyester 5% elastane
220 g / m²

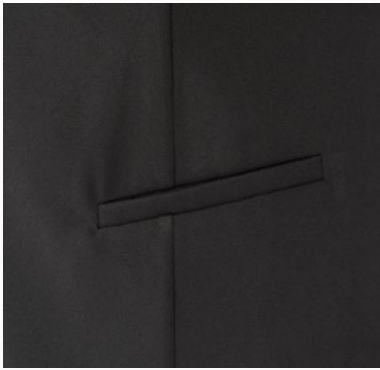
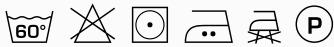
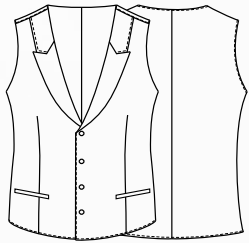

COMFORT



DALILA

Dettagli / Details

- Foderato
- 2 tasche
- 4 bottoni 4 fori
- Fodera stretch sulla schiena

- Lined
- 2 pockets
- 4 buttons with four holes
- Stretch lining on the back

Taglie / Sizes

XS ÷ 3XL Slim Fit

Art. 24P01E406

000 Nero / Black

Tessuto / Fabric

95% poliestere 5% elasthan
95% polyester 5% elastane
220 g / m²

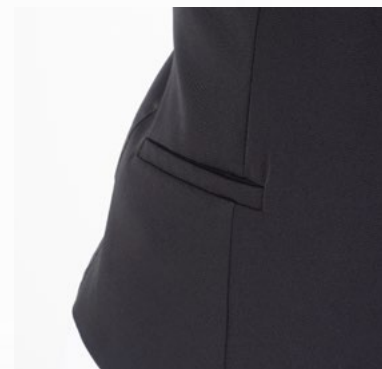
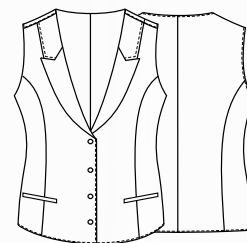

ho.re.ca. & services

Grembiuli
Aprons

IBIZA

Dettagli / Details

- Apertura laterale per tasca pantaloni

- Side opening to reach the pants pocket

Taglie / Sizes

Taglia unica / One size

Art. 24P01H378

00 Bianco / White
000 Nero / Black

Tessuto / Fabric

65% poliestere 35% cotone
65% polyester 35% cotton
200 g / m²

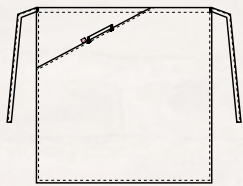

Art. 24P01H378
00 Bianco / White





BRASSERIE

Dettagli / Details

- 1 tasca
- 1 pocket

Taglie / Sizes

Taglia unica / One size

Misure / Dimensions

100x100 cm

Art. 552

000 Nero / Black

Tessuto / Fabric

100% poliestere
100% polyester
220 g / m²

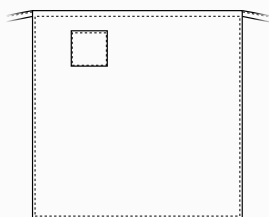

PETRA

Dettagli / Details

- Foderato - 2 tasche
- 4 bottoni 4 fori - Fascette regolabili

- Lined - 2 pockets

- 4 buttons with four-holes buttons - Adjustable buckle

Taglie / Sizes

XS ÷ XXL Slim Fit

Art. 7M108

000 Nero / Black

Tessuto / Fabric

100% poliestere
100% polyester
160 g / m²

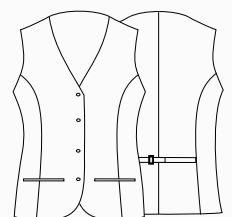



16P01H814 - 16P01H819 - 16P01H813



ARMATURA IN CANVAS, RESISTENTE
ALLO SFREGAMENTO
E DIFFICILMENTE USURABILE

STRONG WEAVING, HARDLY SUBJECT
TO WEAR AND TEAR

PRAGA

Dettagli / Details

- 1 tasca
- 1 pocket

Taglie / Sizes

Taglia unica / One size

Misure / Dimensions

83x62 cm

Art. 16P01H814

000 Nero / Black

Tessuto / Fabric

65% poliestere 35% cotone
65% polyester 35% cotton
310 g / m²

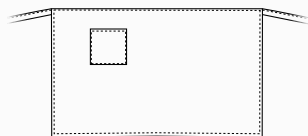

CHARLIE

Dettagli / Details

- 4 tasche
- 4 pockets

Taglie / Sizes

Taglia unica / One size

Misure / Dimensions

70x30 cm

Art. 16P01H819

000 Nero / Black

Tessuto / Fabric

65% poliestere 35% cotone
65% polyester 35% cotton
310 g / m²

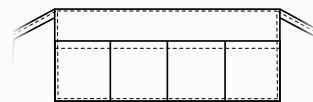

ANVERSA

Dettagli / Details

- Allacciatura collo regolabile con automatici
- 2 tasche

- Adjustable halter with press studs
- 2 pockets

Taglie / Sizes

Taglia unica / One size

Art. 16P01H813

000 Nero / Black

Tessuto / Fabric

65% poliestere 35% cotone
65% polyester 35% cotton
310 g / m²

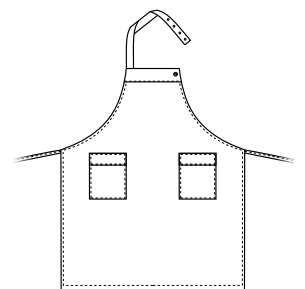
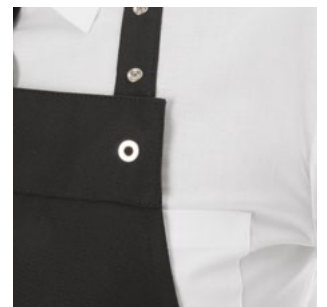

ho.re.ca. & services

Gilet e grembiuli coordinati
Matching waistcoats and aprons



SIVIGLIA

Dettagli / Details

- Allacciatura collo regolabile con bottoni
- 2 tasche

- Adjustable halter with buttons
- 2 pockets

Taglie / Sizes Taglia unica / One size

Art. 24P01H404

000 Nero / Black

Tessuto / Fabric

95% poliestere 5% elasthan
95% polyester 5% elastane
220 g / m²

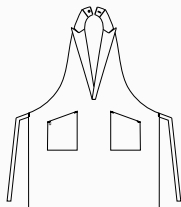

MADRID

Dettagli / Details

- Baschina per nascondere il laccio
- 2 tasche

- Basque to hide the string
- 2 pockets

Taglie / Sizes Taglia unica / One size

Misure / Dimensions

80x70 cm

Art. 24P01H403

000 Nero / Black

Tessuto / Fabric

95% poliestere 5% elasthan
95% polyester 5% elastane
220 g / m²

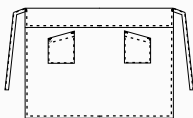

BILBAO

Dettagli / Details

- Allacciatura collo regolabile con bottoni
- 1 portapenne
- 2 tasche

- Adjustable halter with buttons
- 1 pen pocket
- 2 pockets

Taglie / Sizes Taglia unica / One size

Art. 24P01H411

000 Nero / Black

Tessuto / Fabric

95% poliestere 5% elasthan
95% polyester 5% elastane
220 g / m²

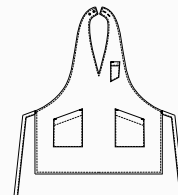

LUXSATIN

LUXSATIN



ANVERSA

Dettagli / Details

- Allacciatura collo regolabile con automatici
- 2 tasche

- Adjustable halter with press studs
- 2 pockets

Taglie / Sizes Taglia unica / One size

Art. 17P01H919

004 Blu / Blue

Tessuto / Fabric

50% cotone 50% poliestere
50% cotton 50% polyester
180 g / m²

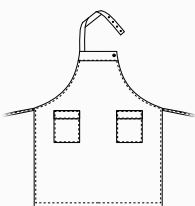

ELETTRA

Dettagli / Details

- Allacciatura collo regolabile con velcro
- 1 tasca

- Adjustable halter with velcro
- 1 pocket

Taglie / Sizes Taglia unica / One size

Art. 17P01H920

004 Blu / Blue

Tessuto / Fabric

50% cotone 50% poliestere
50% cotton 50% polyester
180 g / m²

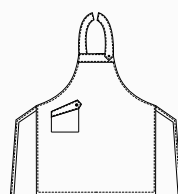

PRAGA

Dettagli / Details

- 1 tasca

- 1 pocket

Taglie / Sizes Taglia unica / One size

Misure / Dimensions 90x67 cm

Art. 17P01H921

004 Blu / Blue

Tessuto / Fabric

50% cotone 50% poliestere
50% cotton 50% polyester
180 g / m²

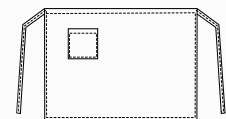

ACCESSORI COORDINABILI
MATCHING ACCESSORIES

pag. 363

TROPEZ

Dettagli / Details

- Allacciatura collo regolabile con fibbia
- 1 taschino portapenne
- 2 tasche
- Inserti in alcantara

- Adjustable halter with buckle
- 1 pen pocket
- 2 pockets
- Alcantara inserts

Taglie / Sizes

Taglia unica / One size

Art. 23P01H149

006 Bordeaux / Burgundy

Art. 20P01H149

073 Beige / Beige

322 Marrone / Brown

019 Grigio chiaro / Light grey

Tessuto / Fabric

100% poliestere

100% polyester

170 g / m²



Art. 23P01H149
006 Bordeaux / Burgundy



Art. 20P01H149
019 Grigio chiaro / Light grey

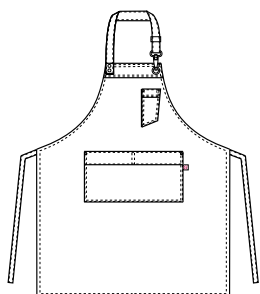

Art. 20P01H149
322 Marrone / Brown



Art. 20P01H149
073 Beige / Beige



Art. 23P01H149
006 Bordeaux / *Burgundy*



NAPOLI

Dettagli / Details

- 1 tasca

- 1 pocket

Taglie / Sizes

Taglia unica / One size

Misure / Dimensions

70x43 cm

Art. 20P01H147

322 Marrone / Brown

Tessuto / Fabric

100% poliestere
100% polyester
170 g / m²

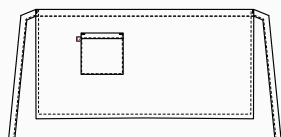

RENO

Dettagli / Details

- Allacciatura collo regolabile con bottoni
- 1 taschino portapenne - 2 tasche

- Adjustable halter with buttons

- 1 pen pocket - 2 pockets

Taglie / Sizes

Taglia unica / One size

Art. 20P01H158

322 Marrone / Brown

Tessuto / Fabric

100% poliestere
100% polyester
170 g / m²

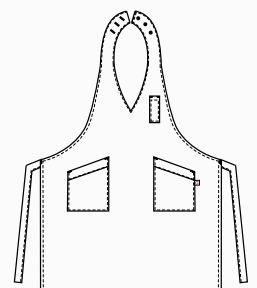



LIONE

Dettagli / Details

- 1 tasca

- 1 pocket

Taglie / Sizes

Taglia unica / One size

Misure / Dimensions

98x70 cm

Art. 20P01H159

322 Marrone / Brown

Tessuto / Fabric

100% poliestere
100% polyester
170 g / m²

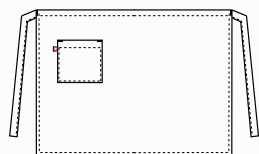

SCOTLAND

Dettagli / Details

- Allacciatura collo regolabile con bottoni
- 1 taschino portapenne - 1 grande tasca

- Adjustable halter with buttons
- 1 pen pocket - 1 big pocket

Taglie / Sizes

Taglia unica / One size

Art. 20P01H2055

322 Marrone / Brown

Tessuto / Fabric

100% poliestere
100% polyester
170 g / m²

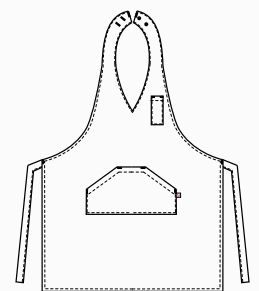



NAPOLI

Dettagli / Details

- 1 tasca

- 1 pocket

Taglie / Sizes

Taglia unica / One size

Misure / Dimensions

70x43 cm

Art. 20P01H147

073 Beige / Beige

Tessuto / Fabric

100% poliestere
100% polyester
170 g / m²

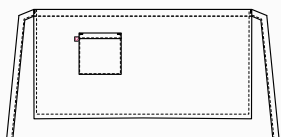

RENO

Dettagli / Details

- Allacciatura collo regolabile con bottoni

- 1 taschino portapenne - 2 tasche

- Adjustable halter with buttons

- 1 pen pocket - 2 pockets

Taglie / Sizes

Taglia unica / One size

Art. 20P01H158

073 Beige / Beige

Tessuto / Fabric

100% poliestere
100% polyester
170 g / m²

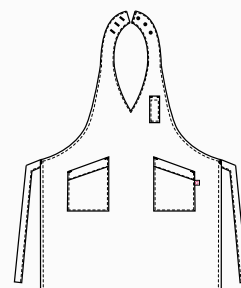



LIONE

Dettagli / Details

- 1 tasca

- 1 pocket

Taglie / Sizes

Taglia unica / One size

Misure / Dimensions

98x70 cm

Art. 20P01H159

073 Beige / Beige

Tessuto / Fabric

100% poliestere
100% polyester
170 g / m²

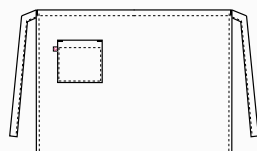

SCOTLAND

Dettagli / Details

- Allacciatura collo regolabile con bottoni
- 1 taschino portapenne - 1 grande tasca

- Adjustable halter with buttons
- 1 pen pocket - 1 big pocket

Taglie / Sizes

Taglia unica / One size

Art. 20P01H2055

073 Beige / Beige

Tessuto / Fabric

100% poliestere
100% polyester
170 g / m²

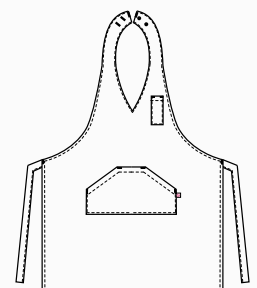



Grembiule **LIONE**
Art. 20P01H159
pag. 169

Grembiule **SCOTLAND**
Art. 20P01H2055
pag. 169





NAPOLI

Dettagli / Details

- 1 tasca

- 1 pocket

Taglie / Sizes

Taglia unica / One size

Misure / Dimensions

70x43 cm

Art. 20P01H147

019 Grigio chiaro / Light grey

Tessuto / Fabric

100% poliestere
100% polyester
170 g / m²

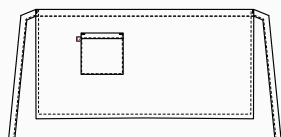

RENO

Dettagli / Details

- Allacciatura collo regolabile con bottoni

- 1 taschino portapenne - 2 tasche

- Adjustable halter with buttons

- 1 pen pocket - 2 pockets

Taglie / Sizes

Taglia unica / One size

Art. 20P01H158

019 Grigio chiaro / Light grey

Tessuto / Fabric

100% poliestere
100% polyester
170 g / m²

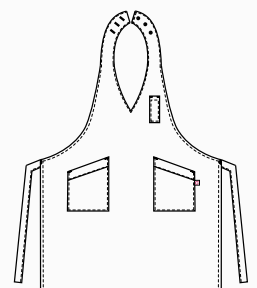



LIONE

Dettagli / Details

- 1 tasca

- 1 pocket

Taglie / Sizes

Taglia unica / One size

Misure / Dimensions

98x70 cm

Art. 20P01H159

019 Grigio chiaro / Light grey

Tessuto / Fabric

100% poliestere
100% polyester
170 g / m²

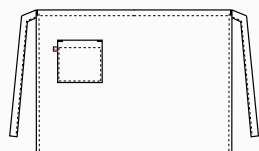

SCOTLAND

Dettagli / Details

- Allacciatura collo regolabile con bottoni
- 1 taschino portapenne - 1 grande tasca

- Adjustable halter with buttons
- 1 pen pocket - 1 big pocket

Taglie / Sizes

Taglia unica / One size

Art. 20P01H2055

019 Grigio chiaro / Light grey

Tessuto / Fabric

100% poliestere
100% polyester
170 g / m²

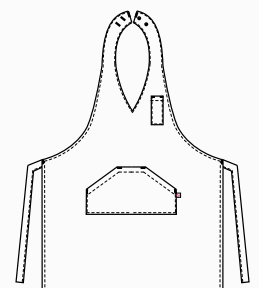



NAPOLI

Dettagli / Details

- 1 tasca

- 1 pocket

Taglie / Sizes

Taglia unica / One size

Misure / Dimensions

70x43 cm

Art. 23P01H147

006 Bordeaux / Burgundy

Tessuto / Fabric

100% poliestere
100% polyester
170 g / m²

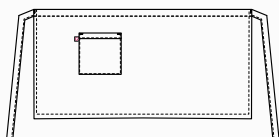

RENO

Dettagli / Details

- Allacciatura collo regolabile con bottoni

- 1 taschino portapenne - 2 tasche

- Adjustable halter with buttons

- 1 pen pocket - 2 pockets

Taglie / Sizes

Taglia unica / One size

Art. 23P01H158

006 Bordeaux / Burgundy

Tessuto / Fabric

100% poliestere
100% polyester
170 g / m²

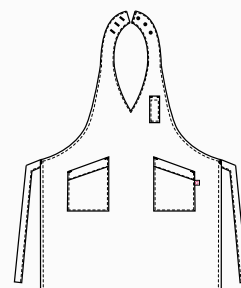



LIONE

Dettagli / Details

- 1 tasca

- 1 pocket

Taglie / Sizes

Taglia unica / One size

Misure / Dimensions

98x70 cm

Art. 23P01H159

006 Bordeaux / Burgundy

Tessuto / Fabric

100% poliestere
100% polyester
170 g / m²

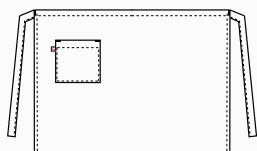

SCOTLAND

Dettagli / Details

- Allacciatura collo regolabile con bottoni
- 1 taschino portapenne - 1 grande tasca

- Adjustable halter with buttons
- 1 pen pocket - 1 big pocket

Taglie / Sizes

Taglia unica / One size

Art. 23P01H2055

006 Bordeaux / Burgundy

Tessuto / Fabric

100% poliestere
100% polyester
170 g / m²

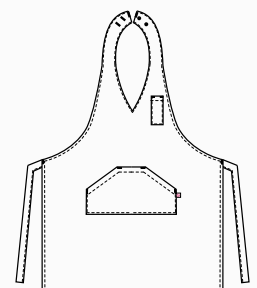





Regali esperienze fatte di suggestioni e originalità?

Attraverso grembiuli, accessori e abiti di tendenza, con la linea **G' Glamour** puoi creare abbinamenti particolari, perfetti per andare incontro ai desideri di una clientela moderna e innovativa.

Gli indumenti giusti per te che vivi la creatività come un'occasione per offrire il meglio.

Glamour

COLLECTION

Do you offer experiences made of suggestions and originality?

*Through trendy aprons, accessories and clothes, with the **G' Glamour** line you can create particular combinations, perfect to meet the needs of a modern and innovative clientele.*

The right clothes for those who live creativity as an opportunity to offer the best.

ho.re.ca.
& services

ho.re.ca. & services

Grembiuli
Aprons

LUNA

Dettagli / Details

- Allacciatura collo regolabile con velcro
- 2 tasche

- Adjustable halter with velcro
- 2 pockets

Taglie / Sizes

Taglia unica / One size

Art. 22P01H069

J222 Jeans marrone chiaro
J222 Light brown jeans

Tessuto / Fabric

100% cotone
100% cotton
320 g / m²

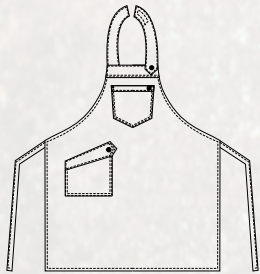

BROOKLYN

Dettagli / Details

- Allacciatura collo regolabile con automatici
- 1 taschino portapenne
- 3 tasche

- Adjustable halter with press studs
- 1 pen pocket
- 3 pockets

Taglie / Sizes

Taglia unica / One size

Art. 22P01H315

J222 Jeans marrone chiaro
J222 Light brown jeans

Tessuto / Fabric

100% cotone
100% cotton
320 g / m²

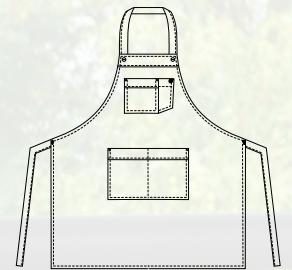

ho.re.ca. & services

Grembiuli
Aprons

OHIO

Dettagli / Details

- Allacciatura collo regolabile con fibbia
- 2 tasche

- Adjustable halter with buckle
- 2 pockets

Taglie / Sizes

Taglia unica / One size

Art. 22P01H316

Q004 Scozzese blu / Scottish blue

Tessuto / Fabric

82% poliestere 15% cotone 3% elasthan
82% polyester 15% cotton 3% elastane
170 g / m²

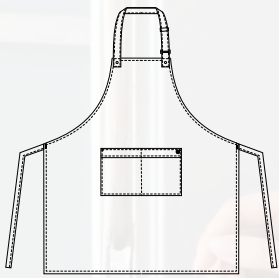

COMFORT



COMFORT



JERSEY

Dettagli / Details

- Allacciatura collo regolabile con fibbia
- 3 taschini portapenne
- 1 tasca
- Porta torcione

- Adjustable halter with buckle
- 3 pen pockets
- 1 pocket
- Cloth ring

Taglie / Sizes

Taglia unica / One size

Art. 22P01H314

J000 Jeans nero / Black jeans

Tessuto / Fabric

75% cotone 23% poliestere 2% elasthan
75% cotton 23% polyester 2% elastane
210 g / m²

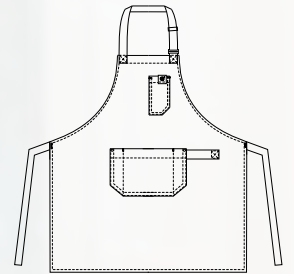

JERSEY

Dettagli / Details

- Allacciatura collo regolabile con fibbia
- 3 taschini portapenne
- 1 tasca
- Porta torcione

- Adjustable halter with buckle
- 3 pen pockets
- 1 pocket
- Cloth ring

Art. 22P01H313

- 000 Nero / Black
- 019 Grigio chiaro / Light Grey
- 102 Verde militare / Military green
- 016 Tortora / Taupe
- 322 Marrone / Brown
- 006 Bordeaux / Burgundy
- 004 Blu / Blue

Taglie / Sizes

Taglia unica / One size

Tessuto / Fabric

65% poliestere 35% cotone
65% polyester 35% cotton
200 g / m²

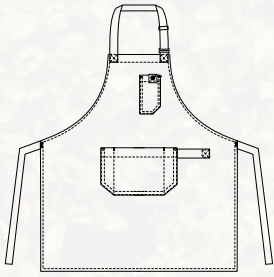

Art. 22P01H313
004 Blu / Blue



Art. 22P01H313
000 Nero / Black



Art. 22P01H313
019 Grigio chiaro / Light Grey



Art. 22P01H313
102 Verde militare / Military green



Art. 22P01H313
016 Tortora / Taupe



Art. 22P01H313
322 Marrone / Brown



Art. 22P01H313
006 Bordeaux / Burgundy



Art. 22P01H313
004 Blu / Blue



DOUGLAS

Dettagli / Details

- Allacciatura collo regolabile con fibbia
- 4 taschini portapenne
- 1 tasca

- Adjustable halter with buckle
- 4 pen pockets
- 1 pocket

Taglie / Sizes

Taglia unica / One size

Art. 18P01H013

004 Blu jeans / Blue jeans

Tessuto / Fabric

100% cotone / cotton
260 g / m²

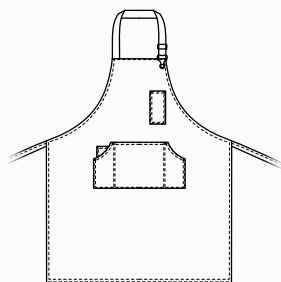

SHANNON

Dettagli / Details

- 3 taschini portapenne
- 1 tasca

- 3 pen pockets
- 1 pocket

Taglie / Sizes

Taglia unica / One size

Misure / Dimensions 70x80 cm

Art. 18P01H014

004 Blu jeans / Blue jeans

Tessuto / Fabric

100% cotone / cotton
260 g / m²

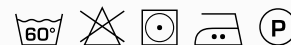
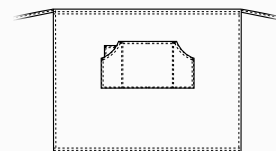

COMFORT



DOUGLAS

Dettagli / Details

- Allacciatura collo regolabile con fibbia
- 4 taschini portapenne - 1 tasca

- Adjustable halter with buckle
- 4 pen pockets - 1 pocket

Taglie / Sizes

Taglia unica / One size

Art. 20P01H013

S322 Scozzese moro / Scottish brown

Tessuto / Fabric

68% poliestere 30% viscosa 2% elasthan
68% polyester 30% viscose 2% elastane
175 g / m²

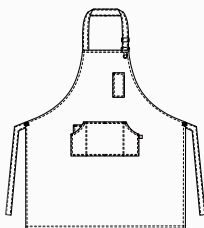

SHANNON

Dettagli / Details

- 3 taschini portapenne
- 1 tasca

- 3 pen pockets
- 1 pocket

Taglie / Sizes

Taglia unica / One size

Art. 20P01H014

S322 Scozzese moro / Scottish brown

Tessuto / Fabric

68% poliestere 30% viscosa 2% elasthan
68% polyester 30% viscose 2% elastane
175 g / m²

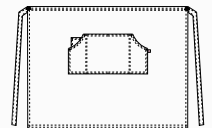

MADRAS

Dettagli / Details

- Allacciatura collo regolabile con bottoni
- 1 taschino portapenne
- 2 tasche

- Adjustable halter with buttons

- 1 pen pocket
- 2 pockets

Taglie / Sizes

Taglia unica / One size

Art. 20P01H157

000 Nero / Black

Tessuto / Fabric

100% poliestere

100% polyester

170 g / m²

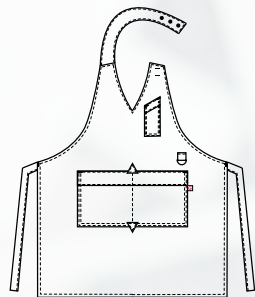



GIUDY

Dettagli / Details

- Allacciatura collo regolabile con bottoni
- 1 taschino portapenne - 1 tasca

- Adjustable halter with buttons
- 1 pen pocket - 1 pocket

Taglie / Sizes

Taglia unica / One size

Art. 20P01H146

F024 Madras / Madras

Tessuto / Fabric

100% poliestere
100% polyester
120 g / m²

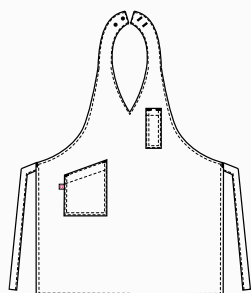

CINDY

Dettagli / Details

- Allacciatura collo regolabile con bottoni
- 1 taschino portapenne - 1 tasca

- Adjustable halter with buttons
- 1 pen pocket - 1 pocket

Taglie / Sizes

Taglia unica / One size

Art. 20P01H155

000 Nero / Black

Tessuto / Fabric

100% poliestere
100% polyester
170 g / m²

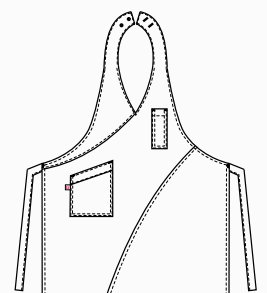

ho.re.ca. & services

Gilet e grembiuli coordinati
Matching waistcoats and aprons

SNOW

Dettagli / Details

- Sfoderato
- 2 tasche
- 6 bottoni automatici
- Fascette regolabili
- Inserti in alcantara

- Unlined
- 2 pockets
- 6 press studs
- Adjustable buckle
- Alcantara inserts

Taglie / Sizes

S ÷ 3XL Slim Fit

Art. 19P01E092

J000 Nero / Black

Tessuto / Fabric

75% cotone 23% poliestere 2% elasthan
75% cotton 23% polyester 2% elastane
210 g / m²

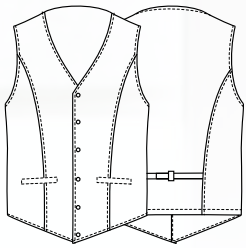

COMFORT

COMFORT

SANSA

Dettagli / Details

- Sfoderato
- 2 tasche
- 5 bottoni automatici
- Fascette regolabili
- Inserti in alcantara
- Unlined
- 2 pockets
- 5 press studs
- Adjustable buckle
- Alcantara inserts

Taglie / Sizes

XS ÷ 3XL Slim Fit

Art. 19P01E093

J000 Nero / Black

Tessuto / Fabric

75% cotone 23% poliestere 2% elasthan
75% cotton 23% polyester 2% elastane
210 g / m²

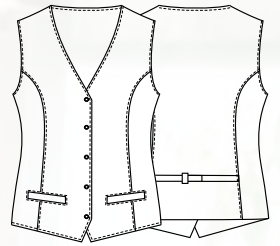

ho.re.ca. & services

Gilet e grembiuli coordinati
Matching waistcoats and aprons

NIZZA

Dettagli / Details

- Allacciatura collo regolabile
- 1 taschino portapenne
- 2 tasche
- Anello porta torcione

- Adjustable halter
- 1 pen pocket
- 2 pockets
- Cloth ring

Taglie / Sizes

Taglia unica / One size

Art. 19P01H071

000 Nero / Black

Tessuto / Fabric

75% cotone 23% poliestere 2% elasthan
75% cotton 23% polyester 2% elastane
210 g / m²

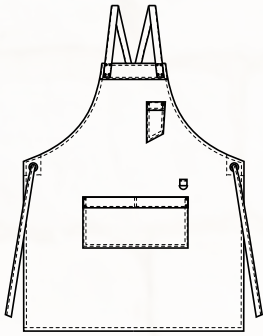

COMFORT



LUNA

Dettagli / Details

- Allacciatura collo regolabile con velcro
- 2 tasche

- Adjustable halter with velcro
- 2 pockets

Taglie / Sizes

Taglia unica / One size

Art. 19P01H069

J000 Nero / Black

Tessuto / Fabric

75% cotone 23% poliestere 2% elasthan
75% cotton 23% polyester 2% elastane
210 g / m²

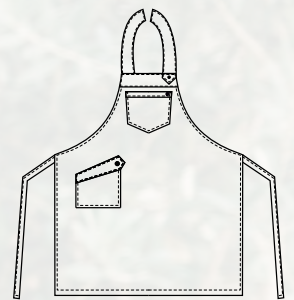

COMFORT



Giblor's
italian worklife specialist



Art. 22P01H067
R012 Rigato verde / Striped green



OREGON

Dettagli / Details

- Allacciatura collo regolabile con fibbia
- 3 tasche
- Anello porta torcione
- Inserti in alcantara

- Adjustable halter with buckle
- 3 pockets
- Cloth ring
- Alcantara inserts

Taglie / Sizes

Taglia unica / One size

Art. 22P01H067

R102 Rigato verde / Green striped

Tessuto / Fabric

85% cotone 15% poliestere
85% cotton 15% polyester
293 g / m²

Art. 19P01H067

R004 Rigato blu / Blue striped
R006 Rigato bordeaux / Burgundy striped

Tessuto / Fabric

85% cotone 15% poliestere
85% cotton 15% polyester
293 g / m²

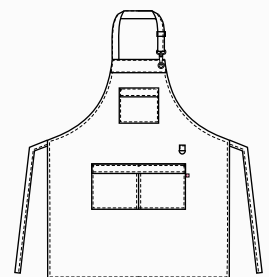

ACCESSORI COORDINABILI
MATCHING ACCESSORIES

pag. 363



CALIFORNIA

Dettagli / Details

- Allacciatura collo regolabile con fibbia
- Laccio collo removibile
- 2 taschini portapenne
- 2 tasche

- Adjustable halter with buckle
- Removable neckline
- 2 pen pockets
- 2 pockets

Taglie / Sizes

Taglia unica / One size

Art. 19P01H072

J004 Jeans blu / Blue jeans

Tessuto 1 / Fabric 1

100% cotone
100% cotton
260 g / m²

Tessuto 2 / Fabric 2

100% poliestere
100% polyester
160 g / m²

Tessuto 3 / Fabric 3

92% poliestere 8% elastan
92% polyester 8% elastane
247 g / m²

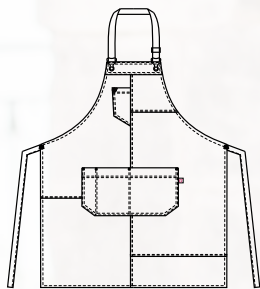

KANSAS

Dettagli / Details

- Allacciatura collo regolabile con fibbia
- Laccio collo removibile
- 2 tasche

- Adjustable halter with buckle
- Removable neckline
- 2 pockets

Taglie / Sizes

Taglia unica / One size

Art. 19P01H073

J004 Jeans blu / Blue jeans

Tessuto 1 / Fabric 1

100% cotone
100% cotton
260 g / m²

Tessuto 2 / Fabric 2

100% poliestere
100% polyester
160 g / m²

Tessuto 3 / Fabric 3

92% poliestere 8% elasthan
92% polyester 8% elastane
247 g / m²

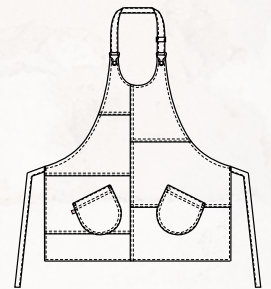

CHICAGO

Dettagli / Details

- Allacciatura collo regolabile con fibbia
- 4 tasche

- Adjustable halter with buckle
- 4 pockets

Taglie / Sizes

Taglia unica / One size

Art. 23P01H363

000 Nero / Black

004 Blu / Blue

019 Grigio chiaro / Light Grey

016 Tortora / Taupe

006 Bordeaux / Burgundy

102 Verde militare / Military green

122 Bruciato / Burnt

213 Prugna / Purple

Tessuto / Fabric

100% cotone

100% cotton

250 g / m²

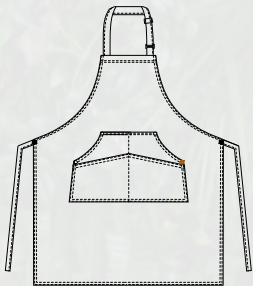

Art. 23P01H363
102 Verde militare / Military green



Art. 23P01H363
000 Nero / Black



Art. 23P01H363
004 Blu / Blue



Art. 23P01H363
019 Grigio chiaro / Light Grey



Art. 23P01H363
016 Tortora / Taupe



Art. 23P01H363
006 Bordeaux / Burgundy



Art. 23P01H363
102 Verde militare / Military green



Art. 23P01H363
122 Bruciato / Burnt



Art. 23P01H363
213 Prugna / Purple



Grembiule **SEATTLE**
Art. 23P01H362
pag. 200

Giblor's
italian worklife specialist



Grebiule **CHICAGO**
Art. 23P01H363
pag. 196



Art. 23P01H362
000 Nero / *Black*



Art. 23P01H362
004 Blu / *Blue*



Art. 23P01H362
019 Grigio chiaro / *Light Grey*



Art. 23P01H362
016 Tortora / *Taupe*



Art. 23P01H362
006 Bordeaux / *Burgundy*



Art. 23P01H362
102 Verde militare / *Military green*



Art. 23P01H362
122 Bruciato / *Burnt*



Art. 23P01H362
213 Prugna / *Purple*

SEATTLE

Dettagli / Details

- 4 tasche

- 4 pockets

Art. 23P01H362

000 Nero / Black

004 Blu / Blue

019 Grigio chiaro / Light Grey

016 Tortora / Taupe

006 Bordeaux / Burgundy

102 Verde militare / Military green

122 Bruciato / Burnt

213 Prugna / Purple

Taglie / Sizes

Taglia unica / One size

Tessuto / Fabric

100% cotone

100% cotton

250 g / m²

Misure / Dimensions

70x43 cm

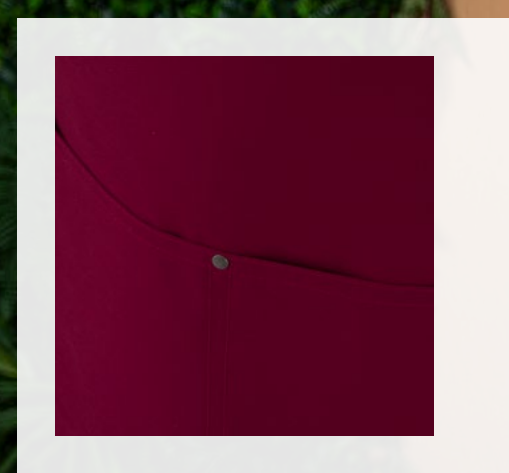

Art. 23P01H362
006 Bordeaux / Burgundy

CHICAGO

Dettagli / Details

- Allacciatura collo regolabile con fibbia
- 4 tasche

- Adjustable halter with buckle
- 4 pockets

Taglie / Sizes

Taglia unica / One size

Art. 23P01H367

J000 Jeans nero / Black jeans

Tessuto / Fabric

70% cotone 28% poliestere 2% elasthan
70% cotton 28% polyester 2% elastane
230 g / m²

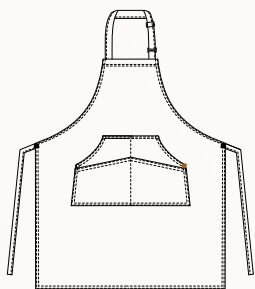

COMFORT



VIRGINIA

Dettagli / Details

- Allacciatura collo regolabile con fibbia
- 2 tasche

- Adjustable halter with buckle
- 2 pockets

Taglie / Sizes

Taglia unica / One size

Art. 23P01H368

J000 Jeans nero / Black jeans

Tessuto / Fabric

70% cotone 28% poliestere 2% elasthan
70% cotton 28% polyester 2% elastane
230 g / m²

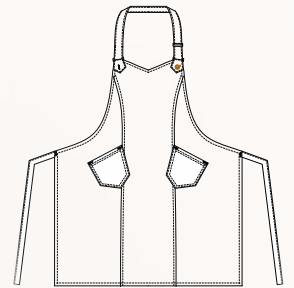

DOUGLAS

Dettagli / Details

- Allacciatura collo regolabile con fibbia
- 4 taschini portapenne
- 1 tasca

- Adjustable halter with buckle
- 4 pen pockets
- 1 pocket

Taglie / Sizes

Taglia unica / One size

Art. 23P01H013

R322 Rigato marrone / Brown striped

Tessuto / Fabric

50% cotone 50% poliestere
50% cotton 50% polyester
200 g / m²

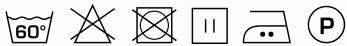
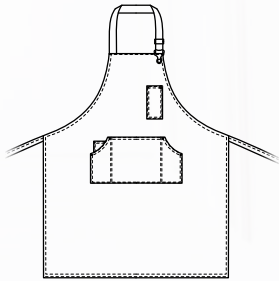

ACCESSORI COORDINABILI
MATCHING ACCESSORIES
pag. 362

COLORADO

Dettagli / Details

- Allacciatura collo regolabile con fibbia
- 1 taschino portapenne
- 1 grande tasca

- Adjustable halter with buckle
- 1 pen pocket
- 1 big pocket

Taglie / Sizes

Taglia unica / One size

Art. 22P01H317

073 Beige / Beige

Tessuto / Fabric

100% cotone

100% cotton

250 g / m²

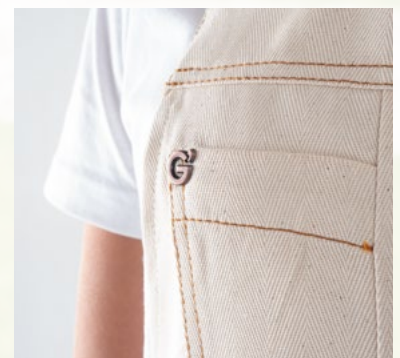
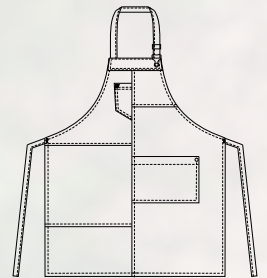



MANCHESTER

Dettagli / Details

- Allacciatura collo regolabile con vela
- 1 taschino portapenne - 3 tasche
- Anello porta torcione

- Adjustable halter with ring
- 1 pen pocket - 3 pockets
- Cloth ring

Taglie / Sizes

Taglia unica / One size

Art. 18P01H019

000 Nero / Black

Tessuto / Fabric

65% poliestere 35% cotone
65% polyester 35% cotton
200 g / m²

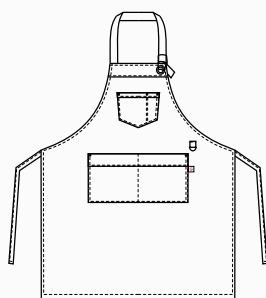

LUNA

Dettagli / Details

- Allacciatura collo regolabile con velcro
- 1 taschino portapenne
- 2 tasche

- Adjustable halter with velcro
- 1 pen pocket
- 2 pockets

Taglie / Sizes

Taglia unica / One size

Art. 18P01H020

000 Nero / Black

Tessuto / Fabric

65% poliestere 35% cotone
65% polyester 35% cotton
200 g / m²

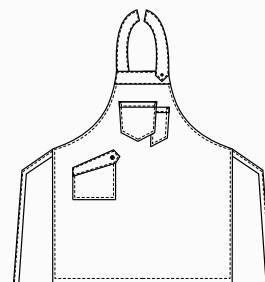

COMFORT



DOUGLAS

Dettagli / Details

- Allacciatura collo regolabile con fibbia
- 4 taschini portapenne
- 1 tasca

- Adjustable halter with buckle
- 4 pen pockets
- 1 pocket

Taglie / Sizes

Taglia unica / One size

Art. 23P01H374

S322 Scozzese marrone / Scottish brown
S118 Scozzese azzurro / Scottish blue

Art. 23P01H371

016 Tortora / Taupe

Tessuto / Fabric

98% cotone 2% elasthan
98% cotton 2% elastane
200 g / m²

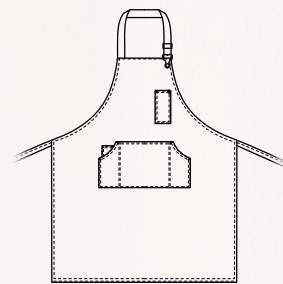

Art. 23P01H374

S322 Scozzese marrone / Scottish brown

ACCESSORI COORDINABILI
COORDINABLE ACCESSORIES

pag. 362



Art. 23P01H374

S118 Scozzese azzurro
Scottish blue



Art. 23P01H371

016 Tortora
Taupe

CHICAGO

Dettagli / Details

- Allacciatura collo regolabile con fibbie
- 4 tasche
- Tela impermeabile

- Adjustable halter with buckle
- 4 pockets
- Waterproof canvas

Taglie / Sizes

Taglia unica / One size

Art. 24P01H409

004 Blu / Blue

016 Tortora / Taupe

Tessuto / Fabric

100% poliestere

100% polyester

215 g / m²

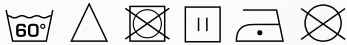
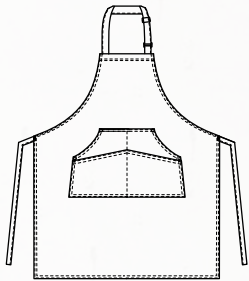

Art. 24P01H409

016 Tortora / Taupe



UTAH

Dettagli / Details

- Allacciatura collo regolabile con automatico
- 2 taschini portapenne
- 1 tasca
- Inserti in ecopelle

- Adjustable halter with press stud
- 2 pen pockets
- 1 pocket
- Eco-leather inserts

Taglie / Sizes

Taglia unica / One size

Art. 22P01H319

000 Nero / Black

Tessuto / Fabric

65% poliestere 35% cotone
65% polyester 35% cotton
310 g / m²

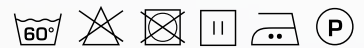
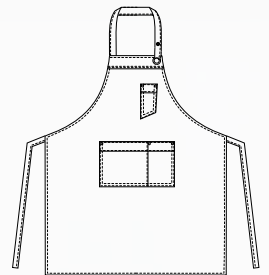

ARMATURA IN CANVAS, RESISTENTE ALLO SFREGAMENTO E DIFFICILMENTE USURABILE

STRONG WEAVING, HARDLY SUBJECT TO WEAR AND TEAR

PICASSO

Dettagli / Details

- Allacciatura collo regolabile con fibbia
- 4 taschini portapenne
- 2 grandi tasche
- Inserti in alcantara
- Tela impermeabile

- Adjustable halter with buckle
- 4 pen pockets
- 2 big pockets
- Alcantara inserts
- Waterproof canvas

Taglie / Sizes

Taglia unica / One size

Art. 19P01H081

000 Nero / Black

Tessuto / Fabric

100% poliestere
100% polyester
215 g / m²

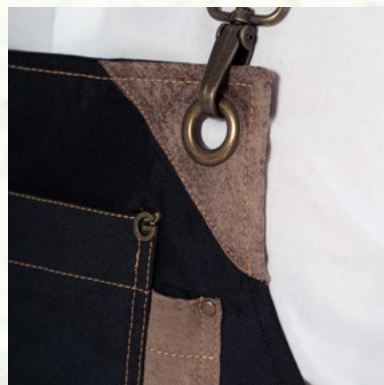
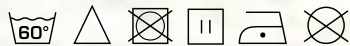
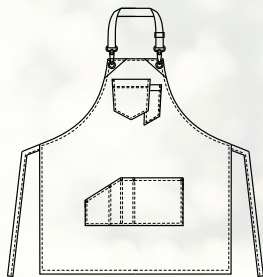

GAUGUIN

Dettagli / Details

- Allacciatura collo regolabile con fibbia
- 3 taschini portapenne
- 3 grandi tasche
- Inserti in ecopelle
- Tela impermeabile

- Adjustable halter with buckle
- 3 pen pockets
- 3 big pockets
- Eco-leather inserts
- Waterproof canvas

Taglie / Sizes

Taglia unica / One size

Art. 19P01H079

004 Blu / Blue

Tessuto 1 / Fabric 1

100% poliestere
100% polyester
215 g / m²

Tessuto 2 / Fabric 2

55% viscosa 45% poliuretano
55% viscose 45% polyurethane
254 g / m²

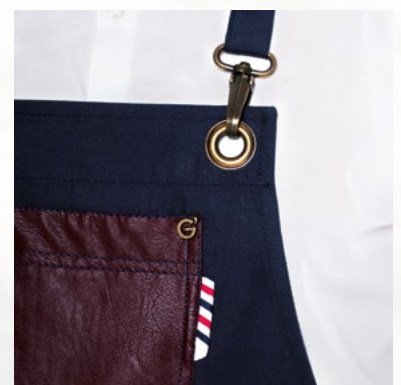
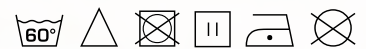
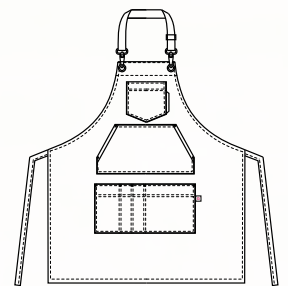





Ti dedichi a un pubblico amante degli stili classici e lontano dalle mode passeggere?

Nella collezione **G'Evergreen** puoi trovare gilet, camicie, accessori e abiti dal mood intramontabile. Capi adatti ad ogni occasione, pensati per te che conosci il fascino della discrezione e sai trasformare la semplicità in un privilegio. Insostituibili compagni di viaggio per chi sa accogliere con classe, creando atmosfere fuori dal tempo.

Evergreen

COLLECTION

Do you dedicate yourself to a public that loves classic styles and is far from passing fashions?

*In the **G' Evergreen** collection you can find vests, shirts, accessories and dresses with a timeless mood. Clothes suitable for every occasion, designed for those who know the charm of discretion and how to transform simplicity into a privilege.*

Irreplaceable traveling companions for those who know how to welcome with class, creating timeless atmospheres.

ho.re.ca.
& services

MIGUEL

Dettagli / Details

- Foderato
- 2 tasche
- 4 bottoni 4 fori
- Fascette regolabili

- Lined
- 2 pockets
- 4 buttons with four-holes
- Adjustable buckle

Taglie / Sizes

XS ÷ 4XL Regular Fit

Art. 106/E

000 Nero / Black

Tessuto / Fabric

100% poliestere
100% polyester
160 g / m²

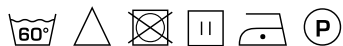
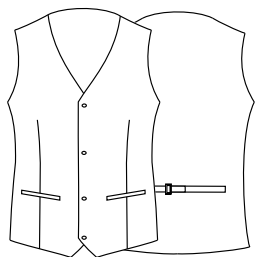

Art. 106BX

006 Bordeaux / Burgundy

100% poliestere / 100% polyester
220 g / m²



Art. 106

004 Blu / Blue

100% poliestere / 100% polyester
160 g / m²

ROSITA

Dettagli / Details

- Sfoderato
- 2 tasche
- 4 bottoni 4 fori
- Fascette regolabili

- Unlined
- 2 pockets
- 4 buttons with four-holes
- Adjustable buckle

Taglie / Sizes

XS ÷ 3XL Regular Fit

Art. 270/E

000 Nero / Black

Tessuto / Fabric

100% poliestere
100% polyester
160 g / m²

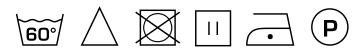
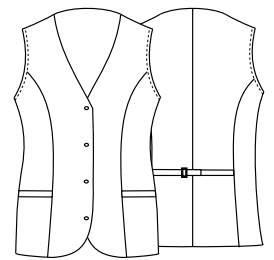

Art. 270BX

006 Bordeaux / Burgundy

100% poliestere / 100% polyester
220 g / m²



Art. 270

004 Blu / Blue

100% poliestere / 100% polyester
160 g / m²



Grebiule **SENA**
Art. 20P01H153
pag. 221



Giblor's
italian worklife specialist

Grembiule **RODANO**
Art. 20P01H154
pag. 221



NAPOLI

Dettagli / Details

- 1 tasca

- 1 pocket

Taglie / Sizes

Taglia unica / One size

Misure / Dimensions

70x43 cm

Art. 20P01H423

G000 Gessato nero
G000 Black pinstriped

Tessuto / Fabric

99% poliestere 1% viscosa
99% polyester 1% viscose
170 g / m²

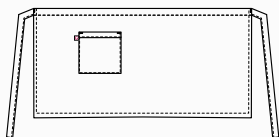

RENO

Dettagli / Details

- Allacciatura collo regolabile con bottoni
- 1 taschino portapenne - 2 tasche

- Adjustable halter with buttons
- 1 pen pocket - 2 pockets

Taglie / Sizes

Taglia unica / One size

Art. 20P01H152

G000 Gessato nero
G000 Black pinstriped

Tessuto / Fabric

99% poliestere 1% viscosa
99% polyester 1% viscose
170 g / m²

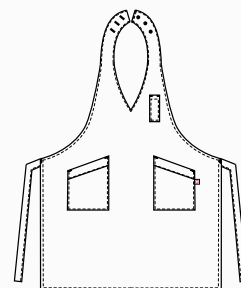



SENNA

Dettagli / Details

- Allacciatura collo regolabile con bottoni
- 2 tasche

- Adjustable halter with buttons
- 2 pockets

Taglie / Sizes

Taglia unica / One size

Art. 20P01H153

G000 Gessato nero
G000 Black pinstriped

Tessuto / Fabric

99% poliestere 1% viscosa
99% polyester 1% viscose
170 g / m²

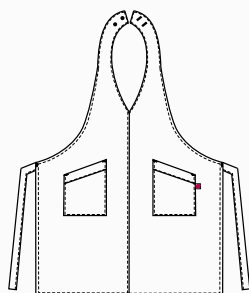

RODANO

Dettagli / Details

- 1 tasca

- 1 pocket

Taglie / Sizes

Taglia unica / One size

Misure / Dimensions

70x98 cm

Art. 20P01H154

G000 Gessato nero
G000 Black pinstriped

Tessuto / Fabric

99% poliestere 1% viscosa
99% polyester 1% viscose
170 g / m²

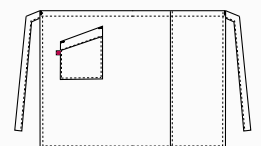



NAPOLI

Dettagli / Details

- 1 tasca

- 1 pocket

Taglie / Sizes

Taglia unica / One size

Misure / Dimensions

70x43 cm

Art. 20P01H423

G119 Gessato grigio
G119 Grey pinstriped

Tessuto / Fabric

99% poliestere 1% viscosa
99% polyester 1% viscose
170 g / m²

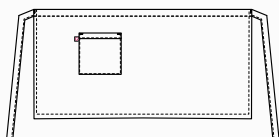

RENO

Dettagli / Details

- Allacciatura collo regolabile con bottoni
- 1 taschino portapenne - 2 tasche

- Adjustable halter with buttons
- 1 pen pocket - 2 pockets

Taglie / Sizes

Taglia unica / One size

Art. 20P01H152

G119 Gessato grigio
G119 Grey pinstriped

Tessuto / Fabric

99% poliestere 1% viscosa
99% polyester 1% viscose
170 g / m²

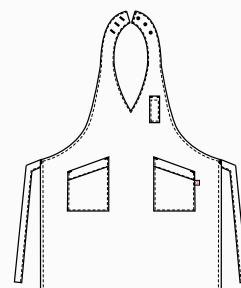



SENNA

Dettagli / Details

- Allacciatura collo regolabile con bottoni
- 2 tasche

- Adjustable halter with buttons
- 2 pockets

Taglie / Sizes

Taglia unica / One size

Art. 20P01H153

G119 Gessato grigio
G119 Grey pinstriped

Tessuto / Fabric

99% poliestere 1% viscosa
99% polyester 1% viscose
170 g / m²

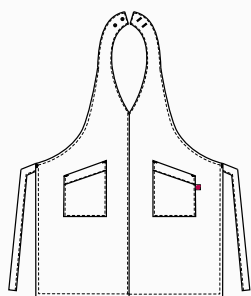

RODANO

Dettagli / Details

- 1 tasca

- 1 pocket

Taglie / Sizes

Taglia unica / One size

Misure / Dimensions

70x98 cm

Art. 20P01H154

G119 Gessato grigio
G119 Grey pinstriped

Tessuto / Fabric

99% poliestere 1% viscosa
99% polyester 1% viscose
170 g / m²

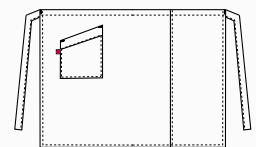



NAPOLI

Dettagli / Details

- 1 tasca

- 1 pocket

Taglie / Sizes

Taglia unica / One size

Misure / Dimensions

70x43 cm

Art. 20P01H423

G006 Gessato bordeaux
G006 Burgundy pinstriped

Tessuto / Fabric

99% poliestere 1% viscosa
99% polyester 1% viscose
170 g / m²

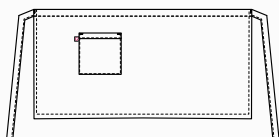

RENO

Dettagli / Details

- Allacciatura collo regolabile con bottoni
- 1 taschino portapenne - 2 tasche

- Adjustable halter with buttons
- 1 pen pocket - 2 pockets

Taglie / Sizes

Taglia unica / One size

Art. 20P01H152

G006 Gessato bordeaux
G006 Burgundy pinstriped

Tessuto / Fabric

99% poliestere 1% viscosa
99% polyester 1% viscose
170 g / m²

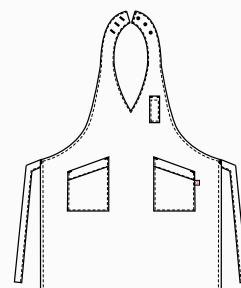



SENNA

Dettagli / Details

- Allacciatura collo regolabile con bottoni
- 2 tasche

- Adjustable halter with buttons
- 2 pockets

Taglie / Sizes

Taglia unica / One size

Art. 20P01H153

G006 Gessato bordeaux
G006 Burgundy pinstriped

Tessuto / Fabric

99% poliestere 1% viscosa
99% polyester 1% viscose
170 g / m²

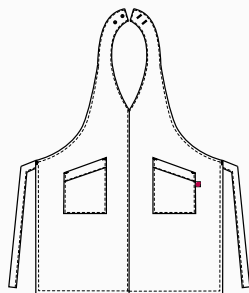

RODANO

Dettagli / Details

- 1 tasca

- 1 pocket

Taglie / Sizes

Taglia unica / One size

Misure / Dimensions

70x98 cm

Art. 20P01H154

G006 Gessato bordeaux
G006 Burgundy pinstriped

Tessuto / Fabric

99% poliestere 1% viscosa
99% polyester 1% viscose
170 g / m²

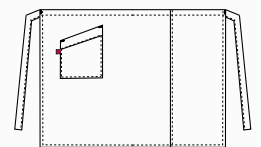



Grembiule **LONDON**
Art. 24P01H2057



SCOTLAND

Dettagli / Details

- Allacciatura collo regolabile con velcro
- 1 taschino portapenne
- 1 grande tasca

- Adjustable halter with velcro
- 1 pen pocket
- 1 big pocket

Taglie / Sizes

Taglia unica / One size

Art. 24P01H2055

000 Nero / Black

Tessuto / Fabric

100% poliestere
100% polyester
160 g / m²

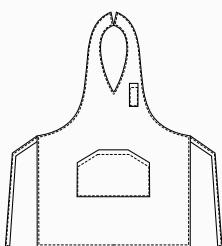

LONDON

Dettagli / Details

- Scamicciato
- 1 grande tasca
- Coperto dietro

- Pinafore
- 1 big pocket
- Covered backside

Taglie / Sizes

Taglia unica / One size

Art. 24P01H2057

000 Nero / Black

Tessuto / Fabric

100% poliestere
100% polyester
160 g / m²

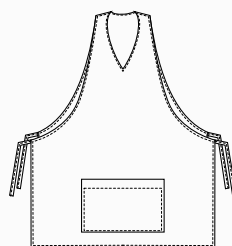

CHARLIE

Dettagli / Details

- 4 tasche

- 4 pockets

Taglie / Sizes

Taglia unica / One size

Misure / Dimensions

70x30 cm

Art. 24P01H2056

000 Nero / Black

Tessuto / Fabric

100% poliestere
100% polyester
160 g / m²

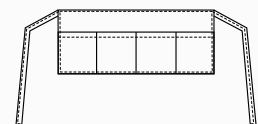



Misure / Dimensions
98x70 cm



Misure / Dimensions
74x100 cm



Misure / Dimensions
83x67 cm

PRAGA

Dettagli / Details

- 1 tasca
- 1 pocket

Taglie / Sizes

Taglia unica / One size

Art. 8M1641

Tessuto / Fabric

65% poliestere 35% cotone
65% polyester 35% cotton
200 g / m²

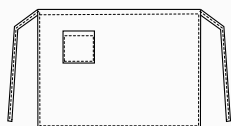

AMSTERDAM

Dettagli / Details

- 2 tasche
- 2 pockets

Taglie / Sizes

Taglia unica / One size

Art. 1100

Tessuto / Fabric

65% poliestere 35% cotone
65% polyester 35% cotton
200 g / m²

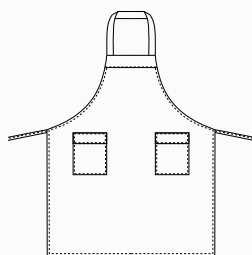

ELETTRA

Dettagli / Details

- Allacciatura collo regolabile con velcro
- 1 tasca
- Adjustable halter with velcro
- 1 pocket

Taglie / Sizes

Taglia unica / One size

Art. 15P01H455

Tessuto / Fabric

65% poliestere 35% cotone
65% polyester 35% cotton
200 g / m²

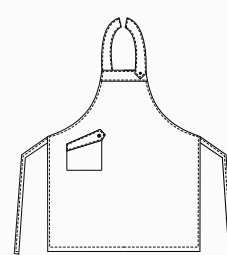



NAPOLI

Dettagli / Details

- 1 tasca

- 1 pocket

Taglie / Sizes Taglia unica / One size

Misure / Dimensions 70x43 cm

Art. 423

000 Nero / Black

Tessuto / Fabric

100% poliestere
100% polyester
220 g / m²

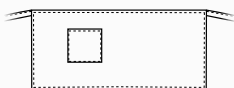

FERRARA

Dettagli / Details

- Allacciatura collo regolabile con bottone
- 1 portapenne - 2 tasche

- Adjustable halter with button
- 1 pen pocket - 2 pockets

Taglie / Sizes Taglia unica / One size

Art. 424

000 Nero / Black

Tessuto / Fabric

100% poliestere
100% polyester
220 g / m²

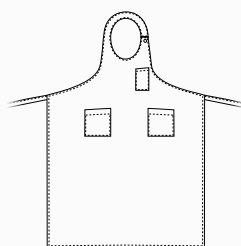

LIONE

Dettagli / Details

- 1 tasca

- 1 pocket

Taglie / Sizes Taglia unica / One size

Misure / Dimensions 98x70 cm

Art. 422

000 Nero / Black

Tessuto / Fabric

100% poliestere
100% polyester
220 g / m²

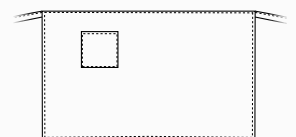

VIENNA

Dettagli / Details

- Allacciatura collo regolabile con automatici
- 2 taschini portapenne
- 1 tasca

- Adjustable halter with press studs
- 2 pen pockets
- 1 pocket

Taglie / Sizes

Taglia unica / One size

Art. 11P08H83

119 Grigio medio / Medium grey
000 Nero / Black
006 Bordeaux / Burgundy
3003F Rosso / Red
321 Bluetto / Royal

Art. 11P08H83B

00 Bianco / White

Tessuto / Fabric

50% cotone 50% poliestere
50% cotton 50% polyester
180 g / m²

LUXSATIN

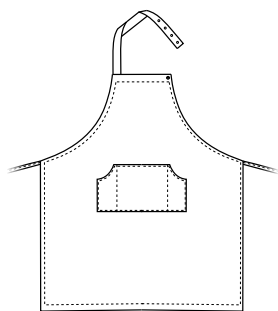



Art. 11P08H83
119 Grigio medio / *Medium grey*
LUXSATIN



Art. 11P08H83
000 Nero / *Black*
LUXSATIN



Art. 11P08H83
006 Bordeaux / *Burgundy*
LUXSATIN



Art. 11P08H83
3003F Rosso / *Red*
LUXSATIN



Art. 11P08H83
321 Bluette / *Royal*
LUXSATIN



Art. 11P08H83B
00 Bianco / *White*
LUXSATIN

VIRGINIA

Dettagli / Details

- Allacciatura collo regolabile con fibbia
- 2 tasche

- Adjustable halter with buckle
- 2 pockets

Art. Q1H00267

C02 Grigio chiaro / Light grey
M12 Grigio medio / Medium grey
U32 Nero / Black
U35 Bordeaux / Burgundy
Z41 Tortora / Taupe
Z43 Verde militare / Military green
Z44 Marrone / Brown
Z47 Prugna / Purple
Z48 Blu / Blue

Taglie / Sizes

Taglia unica / One size

Tessuto / Fabric

65% poliestere 35% cotone
65% polyester 35% cotton
200 g / m²

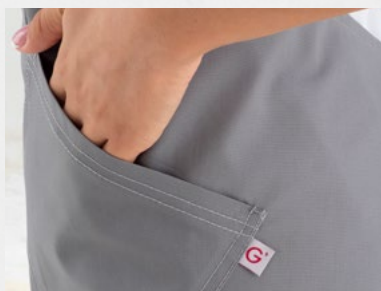
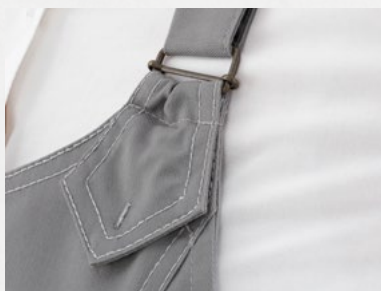
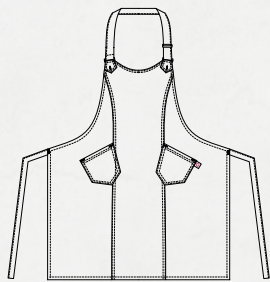

Art. Q1H00267
C02 Grigio chiaro / Light grey



Art. Q1H00267
C02 Grigio chiaro / *Light Grey*



Art. Q1H00267
M12 Grigio medio / *Medium grey*



Art. Q1H00267
U32 Nero / *Black*



Art. Q1H00267
U35 Bordeaux / *Burgundy*



Art. Q1H00267
Z41 Tortora / *Taupe*



Art. Q1H00267
Z43 Verde militare / *Military green*



Art. Q1H00267
Z44 Marrone / *Brown*



Art. Q1H00267
Z47 Prugna / *Purple*



Art. Q1H00267
Z48 Blu / *Blue*

ZANTE

Dettagli / Details

- Allacciatura collo regolabile con fibbia
- 2 grandi tasche

- Adjustable halter with buckle
- 2 big pockets

Taglie / Sizes

Taglia unica / One size

Misure / Dimensions

66x92 cm

Art. Q1H00212

C02 Grigio chiaro / Light grey

M12 Grigio medio / Medium grey

U32 Nero / Black

U35 Bordeaux / Burgundy

Z41 Tortora / Taupe

Z43 Verde militare / Military green

Z44 Marrone / Brown

Z47 Prugna / Purple

Z48 Blu / Blue

Tessuto / Fabric

65% poliestere 35% cotone

65% polyester 35% cotton

200 g / m²

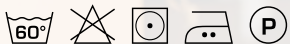
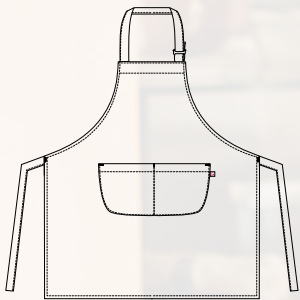

Art. Q1H00212
U32 Nero / Black



Art. Q1H00212
C02 Grigio chiaro / Light grey



Art. Q1H00212
M12 Grigio medio / Medium grey



Art. Q1H00212
U32 Nero / Black



Art. Q1H00212
U35 Bordeaux / Burgundy



Art. Q1H00212
Z41 Tortora / Taupe



Art. Q1H00212
Z43 Militare / Military green



Art. Q1H00212
Z44 Marrone / Brown



Art. Q1H00212
Z47 Prugna / Purple



Art. Q1H00212
Z48 Blu / Blue

MATERA

Dettagli / Details

- 1 tasca
- 1 pocket

Taglie / Sizes

Taglia unica / One size

Misure / Dimensions

105x75 cm

Art. Q1H00213

C02 Grigio chiaro / Light grey
M12 Grigio medio / Medium grey
U32 Nero / Black
U35 Bordeaux / Burgundy
Z41 Tortora / Taupe
Z43 Verde militare / Military green
Z44 Marrone / Brown
Z47 Prugna / Purple
Z48 Blu / Blue

Tessuto / Fabric

65% poliestere 35% cotone
65% polyester 35% cotton
200 g / m²

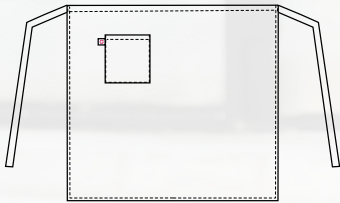

Art. Q1H00213
Z48 Blu / Blue



Art. Q1H00213
C02 Grigio chiaro / Light grey



Art. Q1H00213
M12 Grigio medio / Medium grey



Art. Q1H00213
U32 Nero / Black



Art. Q1H00213
U35 Bordeaux / Burgundy



Art. Q1H00213
Z41 Tortora / Taupe



Art. Q1H00213
Z43 Militare / Military green



Art. Q1H00213
Z44 Marrone / Brown



Art. Q1H00213
Z47 Prugna / Purple



Art. Q1H00213
Z48 Blu / Blue

BARI

Dettagli / Details

- 1 tasca
- 1 pocket

Taglie / Sizes

Taglia unica / One size

Misure / Dimensions

80x45 cm

Art. Q1H00214

C02 Grigio chiaro / Light grey
M12 Grigio medio / Medium grey
U32 Nero / Black
U35 Bordeaux / Burgundy
Z41 Tortora / Taupe
Z43 Verde militare / Military green
Z44 Marrone / Brown
Z47 Prugna / Purple
Z48 Blu / Blue

Tessuto / Fabric

65% poliestere 35% cotone
65% polyester 35% cotton
200 g / m²

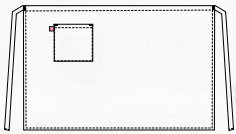

Art. Q1H00214
U35 Bordeaux / Bordeaux



Art. Q1H00214
C02 Grigio chiaro / Light grey



Art. Q1H00214
M12 Grigio medio / Medium grey



Art. Q1H00214
U32 Nero / Black



Art. Q1H00214
U35 Bordeaux / Burgundy



Art. Q1H00214
Z41 Tortora / Taupe



Art. Q1H00214
Z43 Militare / Military green



Art. Q1H00214
Z44 Marrone / Brown



Art. Q1H00214
Z47 Prugna / Purple



Art. Q1H00214
Z48 Blu / Blue

LIPARI

Dettagli / Details

- Allacciatura collo regolabile con bottoni
- 2 taschini portapenne
- 1 grande tasca

- Adjustable halter with buttons
- 2 pen pockets
- 1 big pocket

Taglie / Sizes

Taglia unica / One size

Misure / Dimensions

68x88 cm

Art. Q1H00207

- U32 Nero / Black
- D22 Antracite / Anthracite
- Z44 Marrone / Brown
- U33 Caffè / Coffee
- U35 Bordeaux / Burgundy
- Z46 Fucsia / Fuchsia
- D25 Rosso / Red
- D24 Arancio / Orange
- C03 Giallo / Yellow
- C09 Pistacchio / Pistachio
- Z49 Verde scuro / Dark green
- Z48 Blu / Blue
- U38 Bluette / Royal
- D28 Turchese / Turquoise

Tessuto / Fabric

- 100% poliestere
- 100% polyester
- 220 g / m²

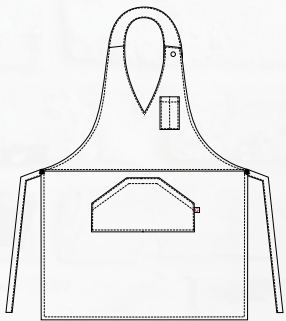

Art. Q1H00207
U33 Caffè / Coffee



Art. Q1H00207
U32 Nero / Black



Art. Q1H00207
D22 Antracite / Anthracite



Art. Q1H00207
Z44 Marrone / Brown



Art. Q1H00207
U33 Caffè / Coffee



Art. Q1H00207
U35 Bordeaux / Burgundy



Art. Q1H00207
Z46 Fucsia / Fuchsia



Art. Q1H00207
D25 Rosso / Red



Art. Q1H00207
D24 Arancio / Orange



Art. Q1H00207
C03 Giallo / Yellow



Art. Q1H00207
C09 Pistacchio / Pistachio



Art. Q1H00207
Z49 Verde scuro / Dark green



Art. Q1H00207
Z48 Blu / Blue



Art. Q1H00207
U38 Bluette / Royal



Art. Q1H00207
D28 Turchese / Turquoise



Art. Q1H00210
U32 Nero / Black



Art. Q1H00210
D22 Antracite / Anthracite



Art. Q1H00210
Z44 Marrone / Brown



Art. Q1H00210
U33 Caffè / Coffee



Art. Q1H00210
U35 Bordeaux / Burgundy



Art. Q1H00210
Z46 Fucsia / Fuchsia



Art. Q1H00210
D25 Rosso / Red



Art. Q1H00210
D24 Arancio / Orange



Art. Q1H00210
C03 Giallo / Yellow



Art. Q1H00210
C09 Pistacchio / Pistachio



Art. Q1H00210
Z49 Verde scuro / Dark green



Art. Q1H00210
Z48 Blu / Blue



Art. Q1H00210
U38 Bluette / Royal



Art. Q1H00210
D28 Turchese / Turquoise

POSITANO

Dettagli / Details

- 2 tasche

- 2 pockets

Taglie / Sizes

Taglia unica / One size

Misure / Dimensions

69x60 cm

Art. Q1H00210

- U32 Nero / Black
- D22 Antracite / Anthracite
- Z44 Marrone / Brown
- U33 Caffè / Coffee
- U35 Bordeaux / Burgundy
- Z46 Fucsia / Fuchsia
- D25 Rosso / Red
- D24 Arancio / Orange
- C03 Giallo / Yellow
- C09 Pistacchio / Pistachio
- Z49 Verde scuro / Dark green
- Z48 Blu / Blue
- U38 Bluette / Royal
- D28 Turchese / Turquoise

Tessuto / Fabric

100% poliestere
100% polyester
220 g / m²

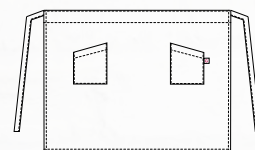

Art. Q1H00210
U32 Nero / Black

PUB

Dettagli / Details

- 3 grandi tasche

- 3 big pockets

Taglie / Sizes

Taglia unica / One size

Misure / Dimensions

51x32 cm

Art. Q1H00211

U32 Nero / Black
D22 Antracite / Anthracite
Z44 Marrone / Brown
U33 Caffè / Coffee
U35 Bordeaux / Burgundy
Z46 Fucsia / Fuchsia
D25 Rosso / Red
D24 Arancio / Orange
C03 Giallo / Yellow
C09 Pistacchio / Pistachio
Z49 Verde scuro / Dark green
Z48 Blu / Blue
U38 Bluette / Royal
D28 Turchese / Turquoise

Tessuto / Fabric

100% poliestere
100% polyester
220 g / m²

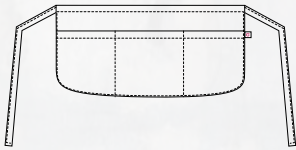

Art. Q1H00211
U32 Nero / Black



Art. Q1H00211
U32 Nero / Black



Art. Q1H00211
D22 Antracite / Anthracite



Art. Q1H00211
Z44 Marrone / Brown



Art. Q1H00211
U33 Caffè / Coffee



Art. Q1H00211
U35 Bordeaux / Burgundy



Art. Q1H00211
Z46 Fucsia / Fuchsia



Art. Q1H00211
D25 Rosso / Red



Art. Q1H00211
D24 Arancio / Orange



Art. Q1H00211
C03 Giallo / Yellow



Art. Q1H00211
C09 Pistacchio / Pistachio



Art. Q1H00211
Z49 Verde scuro / Dark green



Art. Q1H00211
Z48 Blu / Blue



Art. Q1H00211
U38 Bluette / Royal



Art. Q1H00211
D28 Turchese / Turquoise

CAPRI

Dettagli / Details

- Allacciatura collo regolabile con bottoni
- 2 taschini portapenne
- 2 tasche

- Adjustable halter with buttons
- 2 pen pockets
- 2 pockets

Taglie / Sizes

Taglia unica / One size

Misure / Dimensions

81x123 cm

Art. Q1H00208

- U32 Nero / Black
- D22 Antracite / Anthracite
- Z44 Marrone / Brown
- U33 Caffè / Coffee
- U35 Bordeaux / Burgundy
- Z46 Fucsia / Fuchsia
- D25 Rosso / Red
- D24 Arancio / Orange
- C03 Giallo / Yellow
- C09 Pistacchio / Pistachio
- Z49 Verde scuro / Dark green
- Z48 Blu / Blue
- U38 Bluette / Royal
- D28 Turchese / Turquoise

Tessuto / Fabric

- 100% poliestere
- 100% polyester
- 220 g / m²

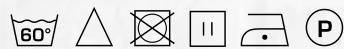
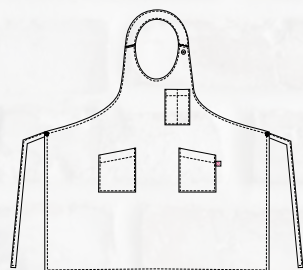

Art. Q1H00208
U35 Bordeaux / Bordeaux



Art. Q1H00208
U32 Nero / Black



Art. Q1H00208
D22 Antracite / Anthracite



Art. Q1H00208
Z44 Marrone / Brown



Art. Q1H00208
U33 Caffè / Coffee



Art. Q1H00208
U35 Bordeaux / Burgundy



Art. Q1H00208
Z46 Fucsia / Fuchsia



Art. Q1H00208
D25 Rosso / Red



Art. Q1H00208
D24 Arancio / Orange



Art. Q1H00208
C03 Giallo / Yellow



Art. Q1H00208
C09 Pistacchio / Pistachio



Art. Q1H00208
Z49 Verde scuro / Dark green



Art. Q1H00208
Z48 Blu / Blue



Art. Q1H00208
U38 Bluette / Royal



Art. Q1H00208
D28 Turchese / Turquoise

LATINA

Dettagli / Details

- Allacciatura collo regolabile con bottoni
- 1 taschino portapenne
- 1 grande tasca

- Adjustable halter with buttons

- 1 pen pocket

- 1 big pocket

Taglie / Sizes

Taglia unica / One size

Misure / Dimensions

67x69 cm

Art. Q1H00209

U32 Nero / Black

D22 Antracite / Anthracite

Z44 Marrone / Brown

U33 Caffè / Coffee

U35 Bordeaux / Burgundy

Z46 Fucsia / Fuchsia

D25 Rosso / Red

D24 Arancio / Orange

C03 Giallo / Yellow

C09 Pistacchio / Pistachio

Z49 Verde scuro / Dark green

Z48 Blu / Blue

U38 Bluette / Royal

D28 Turchese / Turquoise

Tessuto / Fabric

100% poliestere

100% polyester

220 g / m²

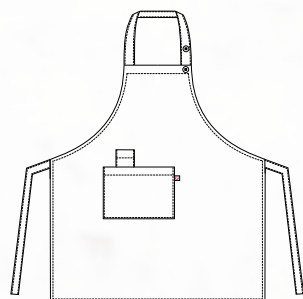

Art. Q1H00209
D25 Rosso / Red



Art. Q1H00209
U32 Nero / Black



Art. Q1H00209
D22 Antracite / Anthracite



Art. Q1H00209
Z44 Marrone / Brown



Art. Q1H00209
U33 Caffè / Coffee



Art. Q1H00209
U35 Bordeaux / Burgundy



Art. Q1H00209
Z46 Fucsia / Fuchsia



Art. Q1H00209
D25 Rosso / Red



Art. Q1H00209
D24 Arancio / Orange



Art. Q1H00209
C03 Giallo / Yellow



Art. Q1H00209
C09 Pistacchio / Pistachio



Art. Q1H00209
Z49 Verde scuro / Dark green



Art. Q1H00209
Z48 Blu / Blue



Art. Q1H00209
U38 Bluette / Royal



Art. Q1H00209
D28 Turchese / Turquoise

GIOIA

Dettagli / Details

- Scamciato
- 1 grande tasca
- Coperto dietro

- Pinafore
- 1 big pocket
- Covered backside

Taglie / Sizes

Taglia unica / One size

Misure / Dimensions

83,5x84 cm

Art. Q2H00218

- U32 Nero / Black
- D22 Antracite / Anthracite
- Z44 Marrone / Brown
- U33 Caffè / Coffee
- U35 Bordeaux / Burgundy
- Z46 Fucsia / Fuchsia
- D25 Rosso / Red
- D24 Arancio / Orange
- C03 Giallo / Yellow
- C09 Pistacchio / Pistachio
- Z49 Verde scuro / Dark green
- Z48 Blu / Blue
- U38 Bluette / Royal
- D28 Turchese / Turquoise

Tessuto / Fabric

100% poliestere
100% polyester
220 g / m²



Art. Q2H00218
U33 Caffè / Coffee



Art. Q2H00218
U32 Nero / Black



Art. Q2H00218
D22 Antracite / Anthracite



Art. Q2H00218
Z44 Marrone / Brown



Art. Q2H00218
U33 Caffè / Coffee



Art. Q2H00218
U35 Bordeaux / Burgundy



Art. Q2H00218
Z46 Fucsia / Fuchsia



Art. Q2H00218
D25 Rosso / Red



Art. Q2H00218
D24 Arancio / Orange



Art. Q2H00218
C03 Giallo / Yellow



Art. Q2H00218
C09 Pistacchio / Pistachio



Art. Q2H00218
Z49 Verde scuro / Dark green



Art. Q2H00218
Z48 Blu / Blue



Art. Q2H00218
U38 Bluette / Royal



Art. Q2H00218
D28 Turchese / Turquoise

accessori

Vari
Various

FASCIA ELASTICA

Taglie / Sizes
XS ÷ 3XL

Art. 437/N
000 Nero / Black

Girovita / Waist	
XS	75 cm
S	80 cm
M	85 cm
L	90 cm
XL	95 cm
XXL	100 cm
XXXL	105 cm



GUANTI

Taglie / Sizes
Taglia unica / One size

Art. 444
00 Bianco / White

Tessuto / Fabric
100% cotone / 100% cotton



TOVAGLIOLO

Taglie / Sizes
45x45 cm

Art. 403
00 Bianco / White

Tessuto / Fabric
100% cotone / 100% cotton
185 g / m²



ALAMARI DORATI

Taglie / Sizes
Taglia unica / One size

Art. AD
Oro / Gold

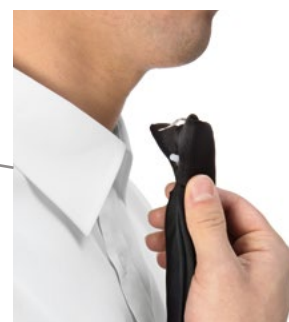

70 cm

CRAVATTA CON NODO

Art. 515
000 Nero / Black

Tessuto / Fabric
100% poliestere
100% polyester

Indossarla non è mai stato
così facile grazie alla clip

*Wearing it has never been
easier thanks to the clip*



Art. 444



Art. 403



Art. AD



Art. 554
TASCA PER PALMARE
PALMTOP POUCH



Art. 556
FODERO SINTETICO
SYNTHETIC WALLET-POUCH



Art. 19P051145
FODERO IN PELLE
LEATHER WALLET-POUCH



Art. 555
PORTAFOGLI
SINTETICO
SYNTHETIC WALLET

Con anello per catena
Ring on the back to insert wallet-chain



Art. 19P051142
PORTAFOGLI IN PELLE
LEATHER WALLET



Art. 19P051143
BRETELLE / SUSPENDERS
000 Nero / Black
100% poliestere / polyester
cm 3

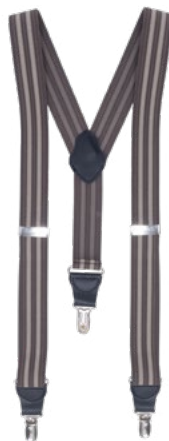

Art. 19P051144
BRETELLE / SUSPENDERS
R322 Marrone rigato / Brown striped
100% poliestere / polyester
cm 3



Art. 19P051144
BRETELLE / SUSPENDERS
R004 Blu rigato / Blue striped
100% poliestere / polyester
cm 3



ART. 20P101145
REGGIMANICA / ARM BAND
000 Nero / Black
100% poliestre / polyester



Art. 19P051126
CINTURA / BELT
000 Nero / Black
100% pelle / leather

Misure / Dimensions
132x3,5 cm